

lenticant[®]

MAQUINARIA Y REPUESTOS PARA LA MADERA

CATÁLOGO DE REPUESTOS

MAQUINARIA PARA LA MADERA



2023

**REPUESTOS
ECONÓMICOS
Y DE ALTA CALIDAD**



www.lenticant.com



Disponemos de una amplia variedad de repuestos/recambios, económicos y de alta calidad para las principales firmas de maquinaria del mercado.

A través de (www.lenticant.com) o por teléfono podrá solicitarnos el repuesto que necesita y en un plazo de 24/48 horas (condicionado a la disponibilidad de stock en el momento de hacer el pedido) lo recibirá en sus instalaciones.

En el caso de no poder identificar exactamente el repuesto que necesita, disponemos de personal cualificado que le ayudará y asesorará para localizarlo.

1 BOLAS PARA MESAS DE AIRE
DE SECCIONADORAS Y
AUTOMATISMOS

5 LÁMINAS DE PROTECCIÓN PARA
SECCIONADORAS

9 PASTILLAS DE CADENA PARA
CHAPADORAS DE CANTOS

24 RUEDAS DEL PRENSOR PARA
CHAPADORAS DE CANTOS

33 DISCOS DE PULIR

38 RODILLOS DE PRESIÓN Y
ALIMENTACIÓN

48 RUEDAS CON COJINETE

53 RESISTENCIAS CALDERÍN DE
COLA

57 CARRIL DE ROLDANAS

RUEDAS Y LENTES PARA CARRO ESCUADRADORAS	59
CNC: JUNTAS PARA VENTOSAS, VÁLVULAS Y FILTROS SECCIONADORA: GOMA PRENSOR	65
CONOS PORTAHERRAMIENTAS Y PINZAS	71
RODILLOS DE ARRASTRE PARA MOLDURERAS Y 4 CARAS	76
RODILLOS PARA ALIMENTADOR TUPÍ	83
CORREAS DE TRANSMISIÓN	87
POLEAS, RUEDAS Y MULTIDIRECCIONALES	93
LÍQUIDOS DE LIMPIEZA Y SISTEMA DE PULVERIZACIÓN	100
OPTIMIZADOR DE CORTE	105

BOLAS PARA MESAS DE AIRE DE SECCIONADORAS Y AUTOMATISMOS

*Otras medidas consultar

Ref	Medidas (mm)
BMA16	Ø16xØ15 aprox

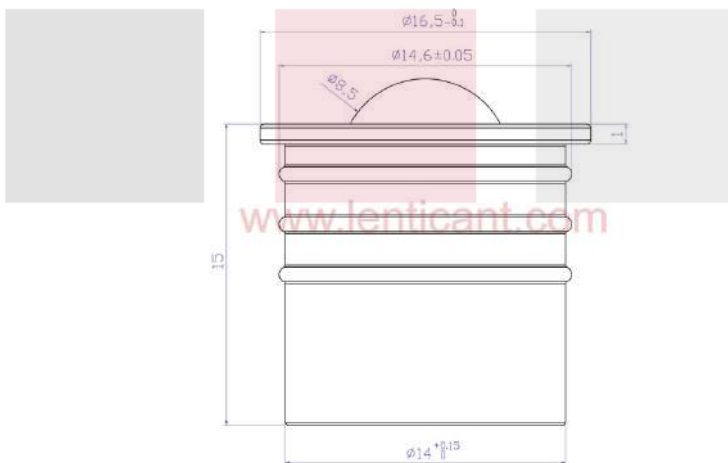
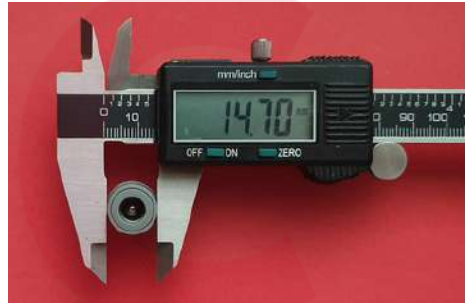



Ref	Medidas (mm)
BMA17	Ø17xØ15 aprox

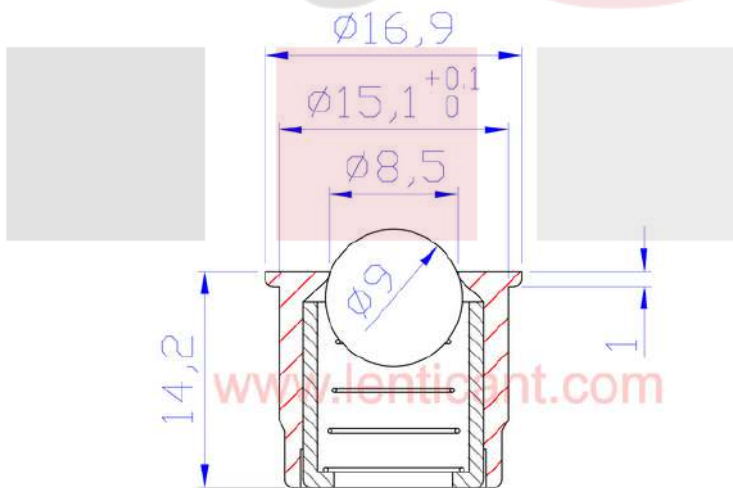

**Otras medidas consultar*

Ref	Medidas (mm)
BMA20	Ø20xØ18 aprox

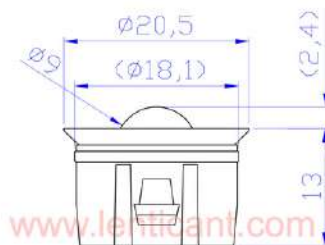
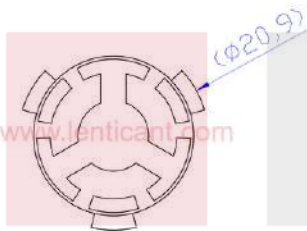
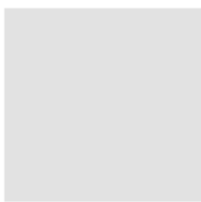

LÁMINAS DE PROTECCIÓN PARA SECCIONADORAS

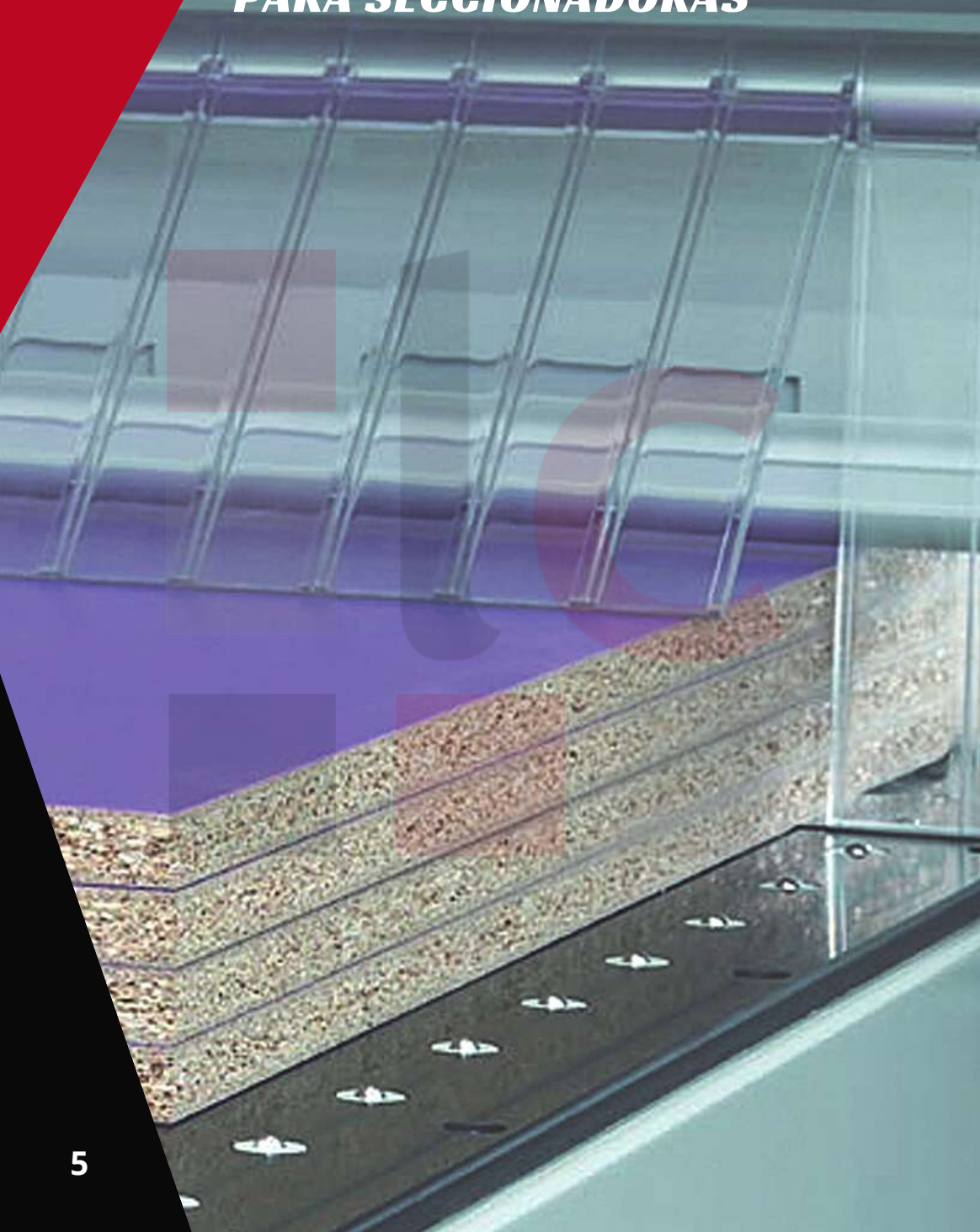

**Otras medidas consultar*



Ref	Medidas (mm)
-----	--------------

LPG22	222x49 aprox
--------------	---------------------

**TAMBIÉN DISPONEMOS DE TODO
TIPO DE REPUESTOS PARA
SECCIONADORAS GIBEN**

PÍDANOS PRESUPUESTO SIN COMPROMISO.





Ref	Medidas (mm)
LPH23	230x30 aprox

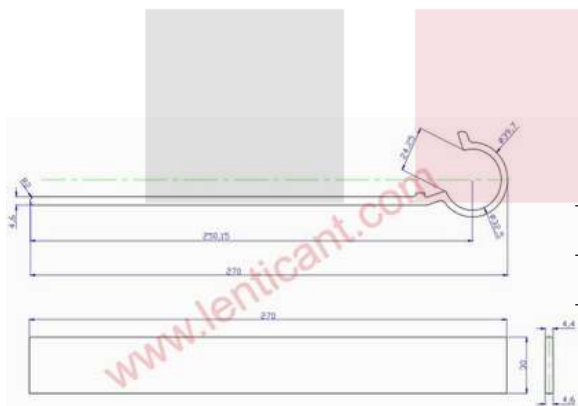
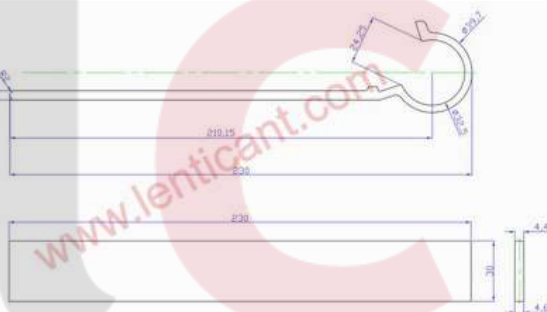

Ref	Medidas (mm)
LPH27	270x30 aprox

**Otras medidas consultar*

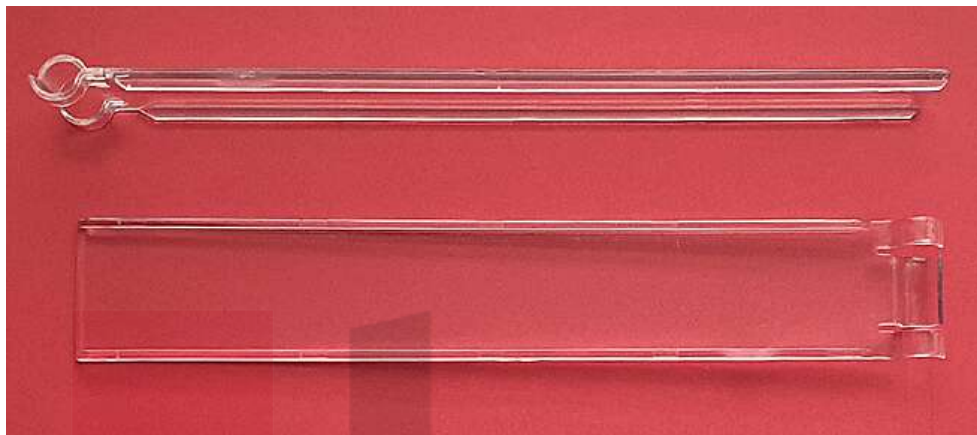

Ref	Medidas (mm)
-----	--------------

LPS26	274x45 aprox
--------------	---------------------

Ref	Medidas (mm)
-----	--------------

LPS83	200X28/34X50 aprox
--------------	---------------------------



PASTILLAS DE CADENA PARA CHAPADORAS DE CANTOS



Ref	Medidas (mm)
PHG01	79x61 aprox



Ref	Medidas (mm)
PHG02	98x80 aprox



Ref	Medidas (mm)
PHG04	98x80 aprox





Ref	Medidas (mm)
PHG05	80x62 aprox



Ref	Medidas (mm)
PHG06	80x30 aprox

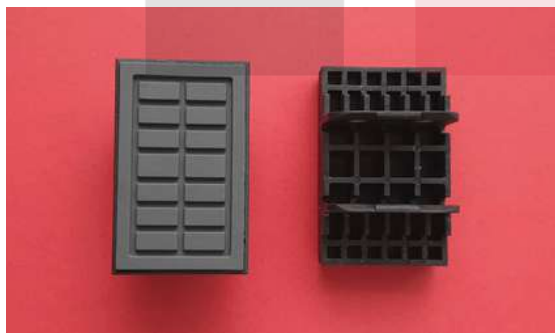

Ref	Medidas (mm)
PHG10	80x50 aprox

Ref	Medidas (mm)
PSM07	71x48 aprox



Ref	Medidas (mm)
PSM11	63x37 aprox



Ref	Medidas (mm)
PSM11-B	62,5x37 aprox



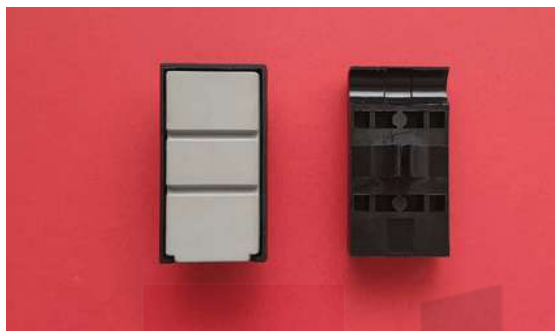

Ref	Medidas (mm)
PSM12	70x37 aprox

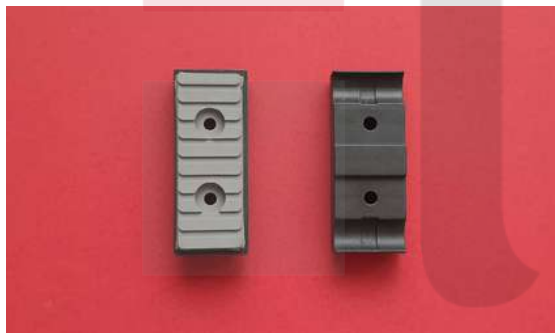

Ref	Medidas (mm)
PSM13	63x25 aprox

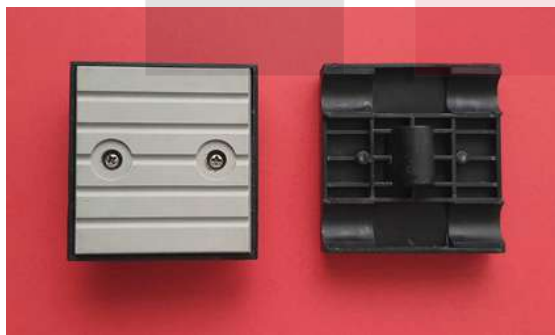

Ref	Medidas (mm)
PSM14	80x75 aprox

**Otras medidas consultar*

Ref	Medidas (mm)
PSM15	80x75 aprox

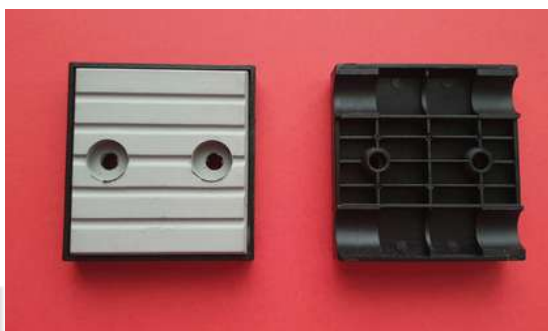

Ref	Medidas (mm)
PSM24	80x62 aprox



Ref	Medidas (mm)
PBE25	110x80 aprox



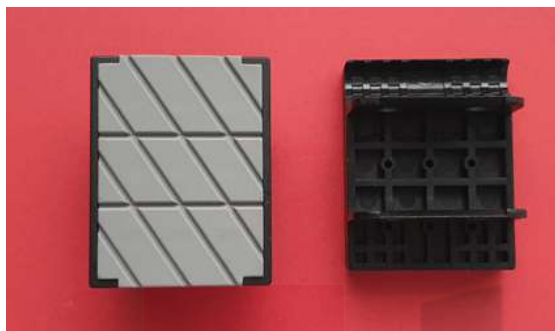

Ref	Medidas (mm)
PBE27	80x62 aprox

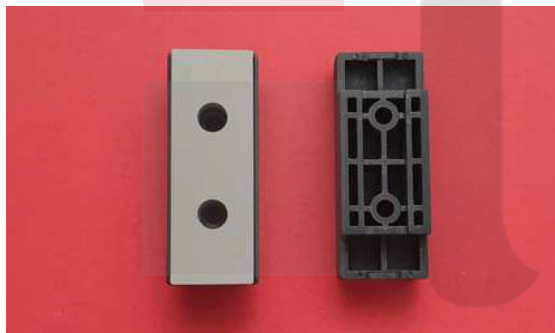

Ref	Medidas (mm)
PBC30	80x30 aprox

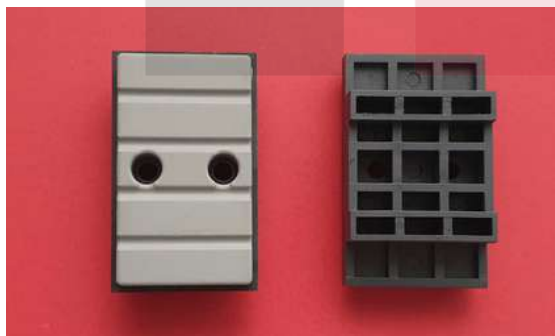

Ref	Medidas (mm)
PBC50	80x50 aprox

**Otras medidas consultar*

Ref	Medidas (mm)
PCA17	95x48 aprox

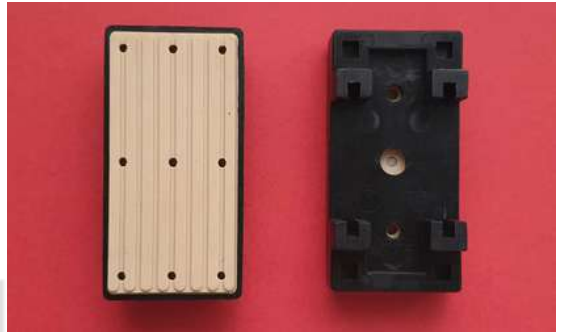

Ref	Medidas (mm)
POT16	79x72prox



Ref	Medidas (mm)
PIA08	80x60 aprox





Ref	Medidas (mm)
PIM21	85X82 aprox



Ref	Medidas (mm)
PIM22	70x62 aprox

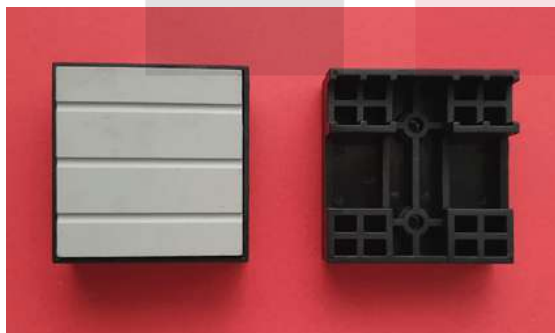

Ref	Medidas (mm)
PHR20	72x70 aprox

Ref	Medidas (mm)
PHR28	72x36 aprox



Ref	Medidas (mm)
PGO19	70x48 aprox



Ref	Medidas (mm)
PFL23	80x72 aprox

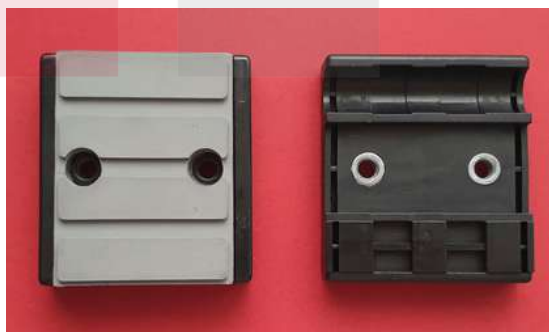



Ref	Medidas (mm)
PGK65	65x55 aprox



Ref	Medidas (mm)
PGK82	82x75 aprox

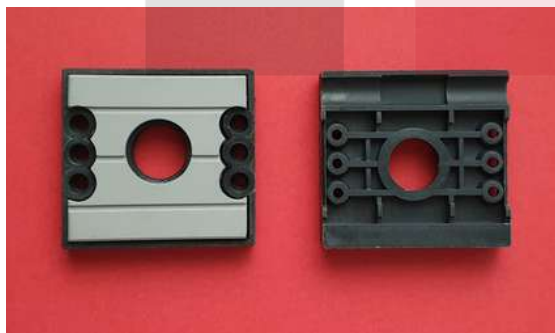

Ref	Medidas (mm)
PP28A	77x72 aprox

Ref	Medidas (mm)
PP28C	77x72 aprox

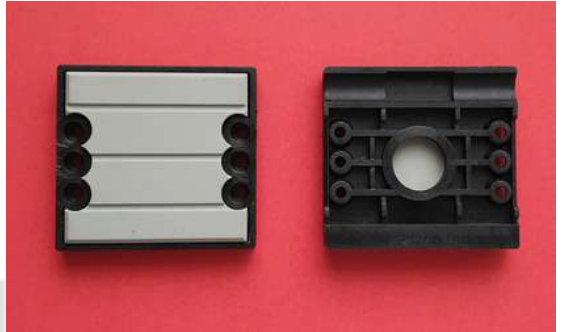

Ref	Medidas (mm)
PP25A	140x73 aprox

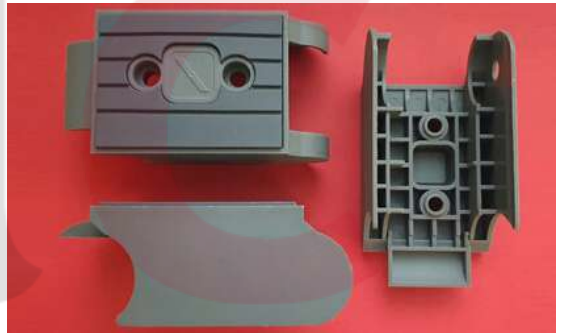

Ref	Medidas (mm)
PP29A	96x78 aprox



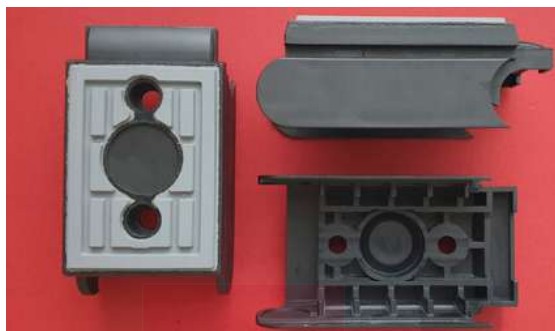

Ref	Medidas (mm)
PP034	127x70 aprox

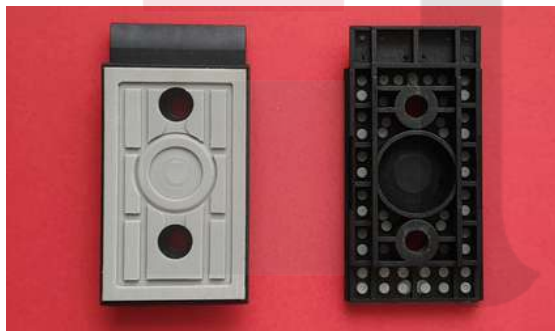

Ref	Medidas (mm)
PP035	115x59 aprox



Ref	Medidas (mm)
PP036	115x69 aprox

Ref	Medidas (mm)
PP038	115x62 aprox



Ref	Medidas (mm)
PP039	115x68 aprox



Ref	Medidas (mm)
PP042	115x62 aprox





Ref	Medidas (mm)
PP043-A	98x80 aprox



Ref	Medidas (mm)
PP043-B	98x80 aprox



Ref	Medidas (mm)
PP043-C	98x80 aprox

RUEDAS PRENSOR PARA CHAPADORA DE CANTOS





Ref	Medidas (mm)
RHG01	Ø70xØ20x25



Ref	Medidas (mm)
RHG06	Ø70xØ18x25

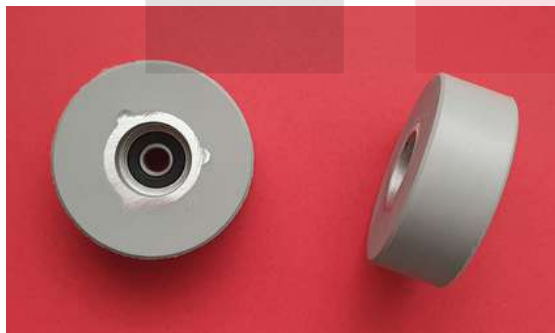

Ref	Medidas (mm)
RSM27-A	Ø65xØ8x25

Ref	Medidas (mm)
RSM27-B	Ø65xØ8x14

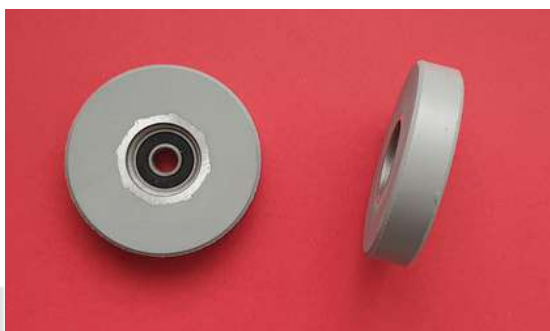

Ref	Medidas (mm)
RSM11-A	Ø48xØ8x25



Ref	Medidas (mm)
RSM11-B	Ø48xØ8x12



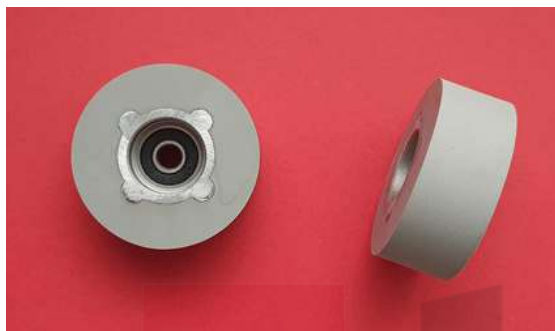

Ref	Medidas (mm)
RBE26-A	Ø60xØ8x24

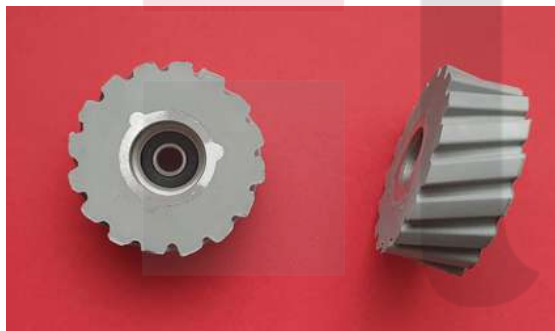

Ref	Medidas (mm)
RBE26-B	Ø62xØ8x25

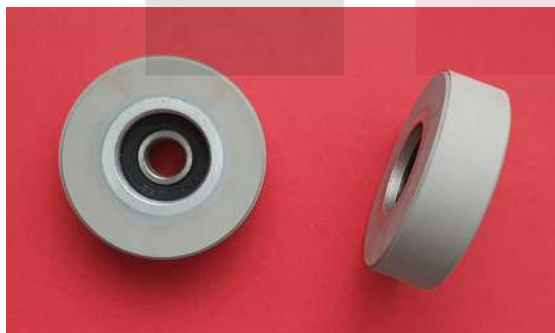

Ref	Medidas (mm)
RBC65	Ø65xØ12x20

Ref	Medidas (mm)
RCA17	Ø62xØ16x24

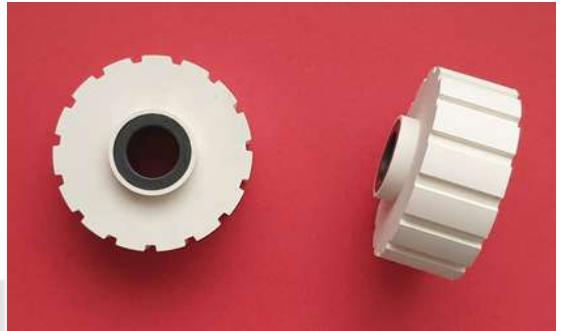

Ref	Medidas (mm)
RIA08	Ø70xØ18x25

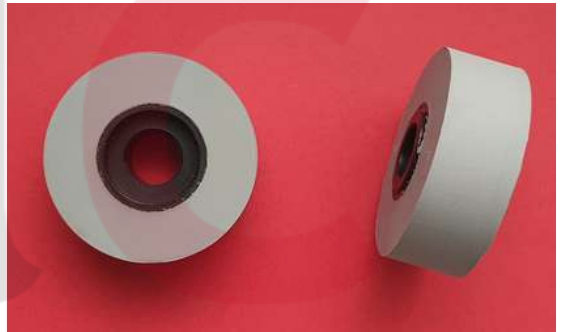

Ref	Medidas (mm)
RLC20	Ø60xØ12x20





Ref	Medidas (mm)
RFG23-A	Ø65xØ8x28

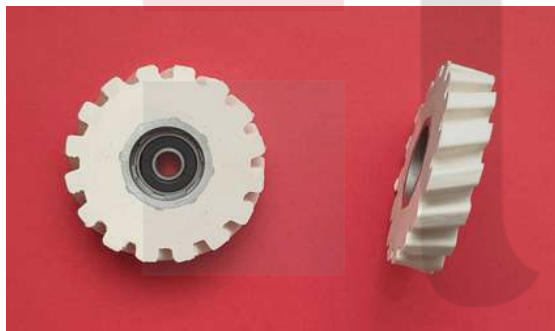

Ref	Medidas (mm)
RFG23-B	Ø65xØ8x14

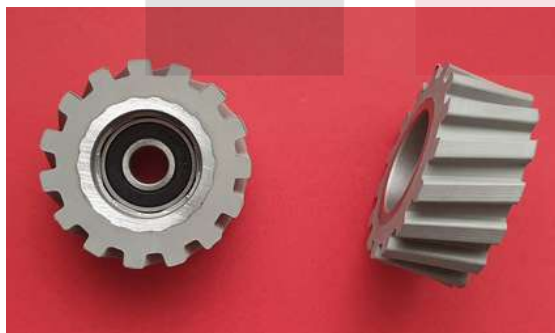

Ref	Medidas (mm)
RFG23-C	Ø65xØ12x28

Ref	Medidas (mm)
RFG23-D	Ø65xØ12x14



Ref	Medidas (mm)
RFG23-E	Ø65xØ12x28

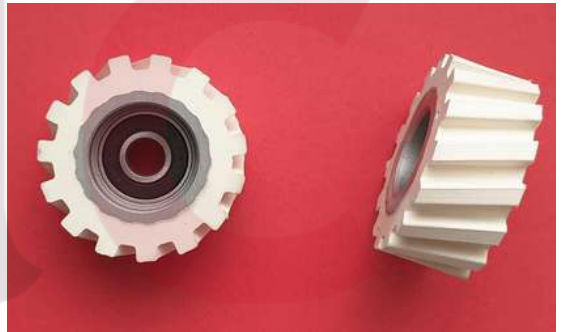

Ref	Medidas (mm)
RFG23-F	Ø65xØ12x14

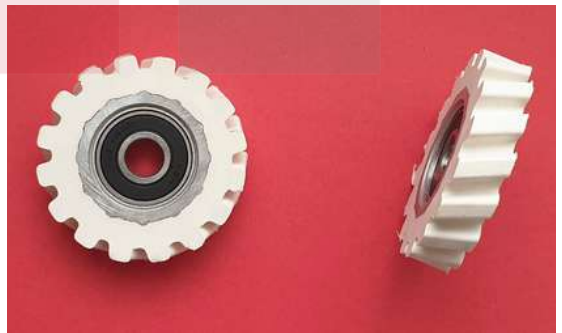



Ref	Medidas (mm)
RFG23-G	Ø65xØ12x28

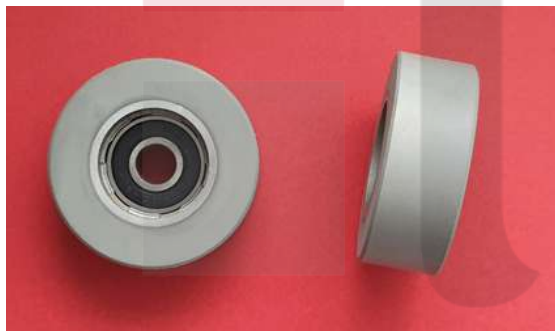

Ref	Medidas (mm)
RFR18	Ø65xØ12x25



Ref	Medidas (mm)
RGK56	Ø65xØ10x20

Ref	Medidas (mm)
RGK69	Ø69xØ10x18



Ref	Medidas (mm)
RGK70	Ø70xØ10x20



Ref	Medidas (mm)
RGO60	Ø60xØ8x20

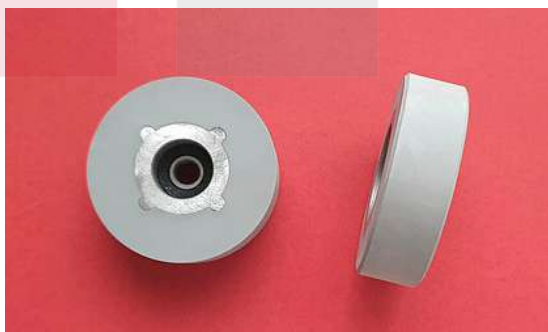

DISCOS DE PULIR



Ref	Medidas (mm)
DP064-SS	Ø125xØ50x25



Ref	Medidas (mm)
DP064-A	Ø150xØ50x25



Ref	Medidas (mm)
DP064-A2	Ø150xØ55x25



Ref	Medidas (mm)
DP064-SB	Ø160xØ50x25



Ref	Medidas (mm)
DP064-B	Ø180xØ50x25



Ref	Medidas (mm)
DP065	Ø120xØ19x12



Ref	Medidas (mm)
DP065-A	Ø150xØ19x12

Ref	Medidas (mm)
DP065-B	Ø150xØ19x20



Ref	Medidas (mm)
DP066	Ø200xØ19x25

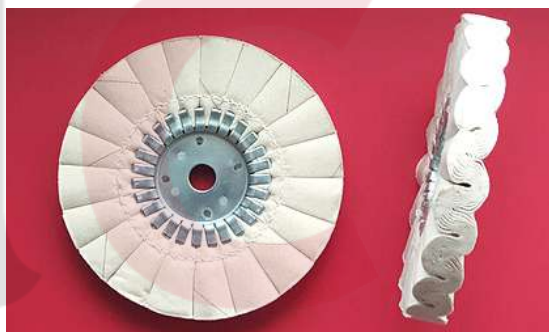

Ref	Medidas (mm)
DP067	Ø150xØ19x25



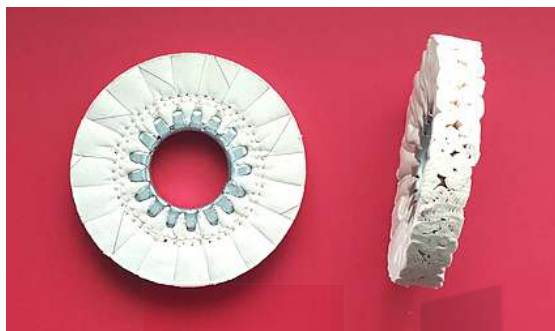

Ref	Medidas (mm)
DP069	Ø150xØ60x25

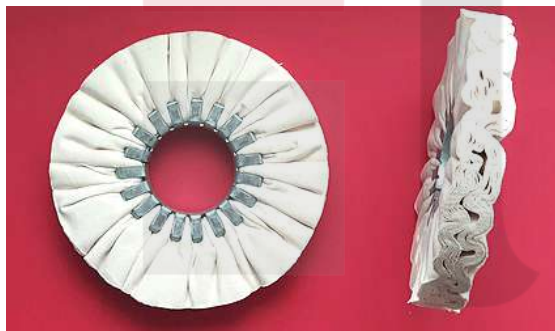

Ref	Medidas (mm)
DP070	Ø178xØ56x25



Ref	Medidas (mm)
DSB150/50	Ø150xØ50x25
DSB200/76	Ø200xØ76x25

RODILLOS DE PRESIÓN Y ALIMENTACIÓN

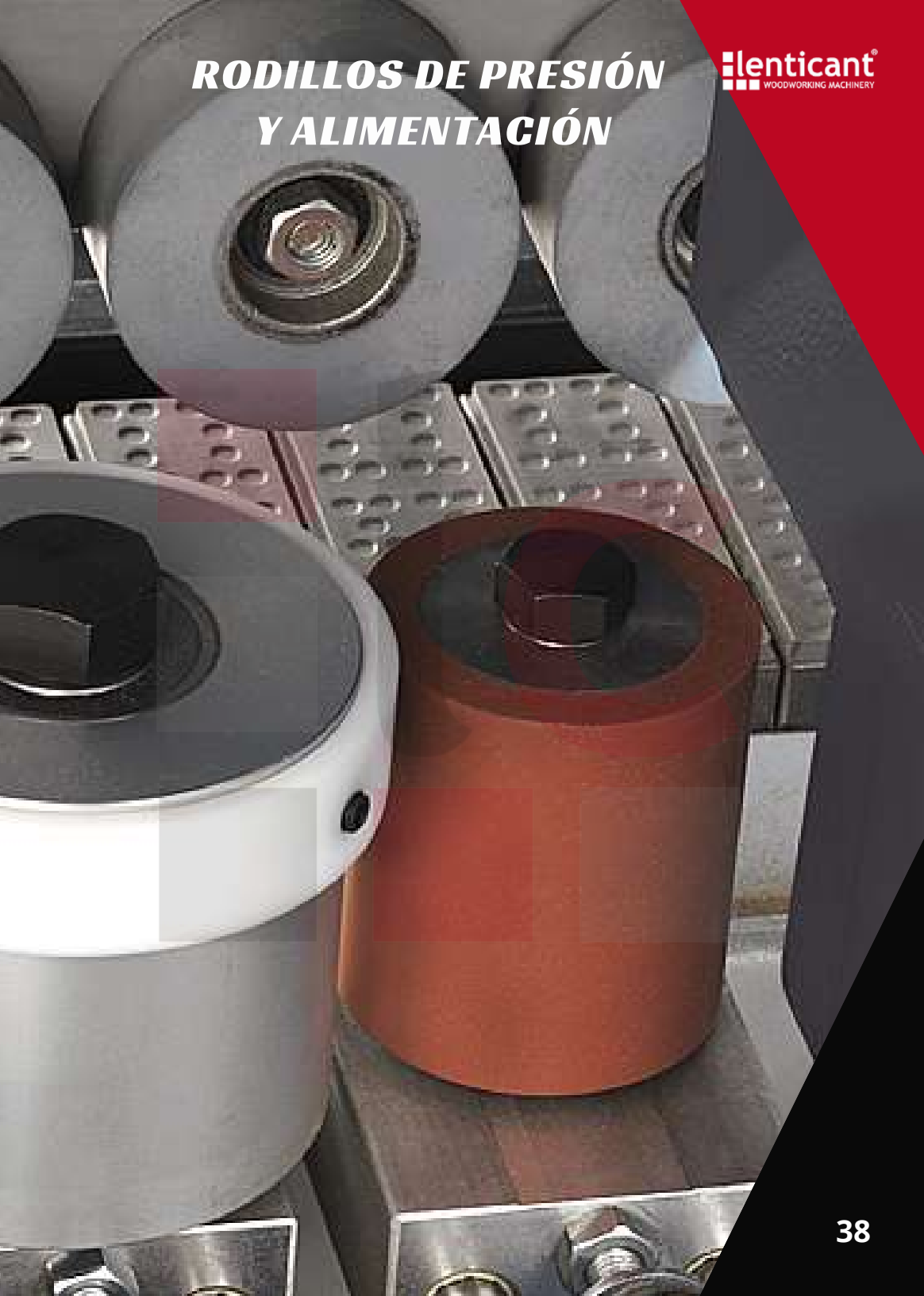



Ref	Medidas (mm)
R090-1	Ø30xØ15x100



Ref	Medidas (mm)
R090-2	Ø25xØ15x100

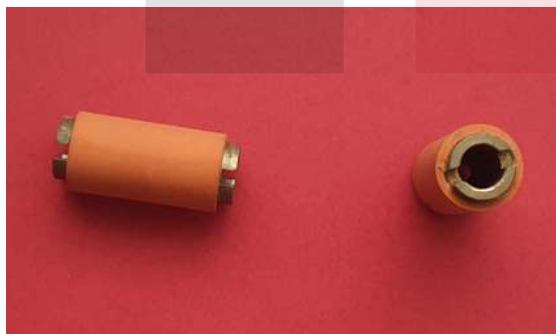

Ref	Medidas (mm)
R090-3	Ø16xØ8x36

Ref	Medidas (mm)
R090-5	Ø24xØ12x80



Ref	Medidas (mm)
R090-5B	Ø25xØ12x73

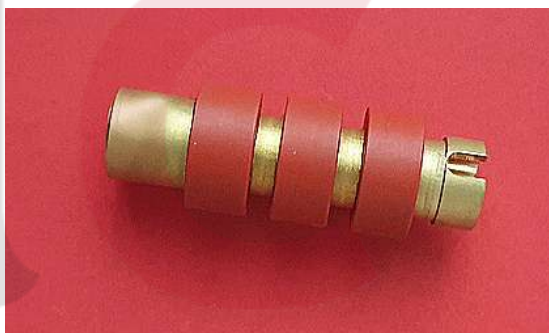

Ref	Medidas (mm)
R090-6	Ø15xØ8x36





Ref	Medidas (mm)
R090-6B	Ø15xØ8x36



Ref	Medidas (mm)
R090-11	Ø15xØ8x36

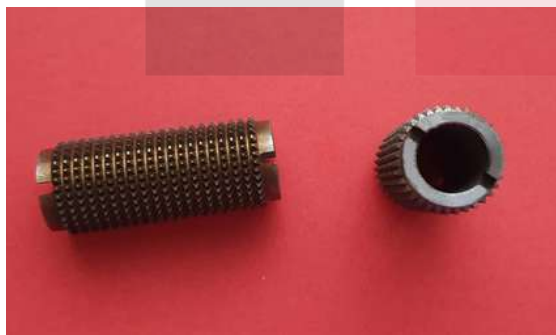

Ref	Medidas (mm)
R090-11B	Ø26xØ16x60

Ref	Medidas (mm)
R090-12	Ø26xØ16x60



Ref	Medidas (mm)
R090-13	Ø24xØ17x52

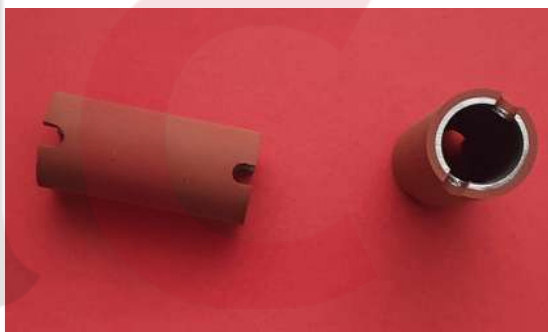

Ref	Medidas (mm)
R090-13B	Ø24xØ17x52





Ref	Medidas (mm)
R090-23	Ø20xØ8x36

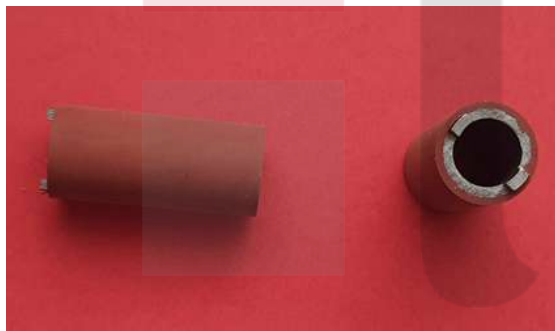

Ref	Medidas (mm)
R090-32	Ø18xØ12x40



Ref	Medidas (mm)
R090-36	Ø18xØ8x55

Ref	Medidas (mm)
R090-38	Ø24,5xØ8x44



Ref	Medidas (mm)
R094-1	Ø65xØ8x50

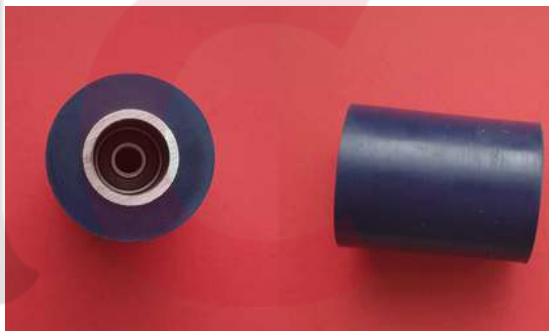

Ref	Medidas (mm)
R094-2	Ø33xØ12x40

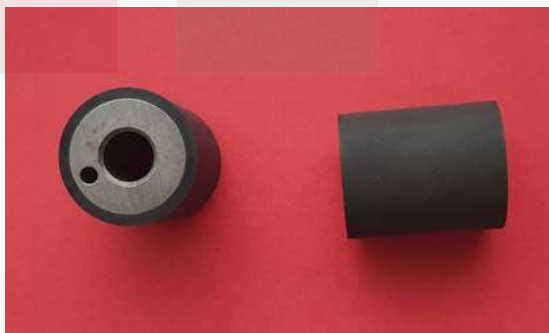



Ref	Medidas (mm)
R094-2B	Ø33xØ12x40

**con pasador*

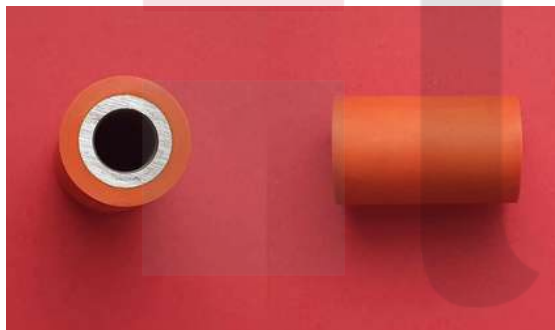

Ref	Medidas (mm)
R094-3	Ø30xØ14x50

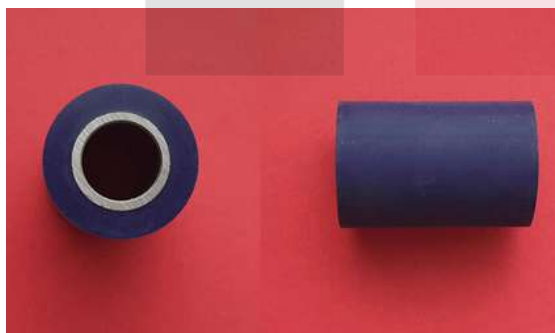

Ref	Medidas (mm)
R094-4	Ø40xØ20x60

Ref	Medidas (mm)
R094-5	Ø36xØ18x70



Ref	Medidas (mm)
R094-6	Ø40xØ16x68

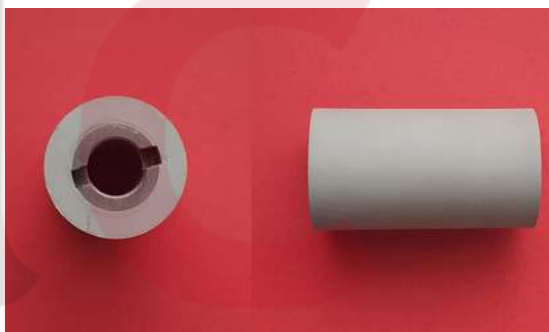

Ref	Medidas (mm)
R094-7	Ø35xØ8x40

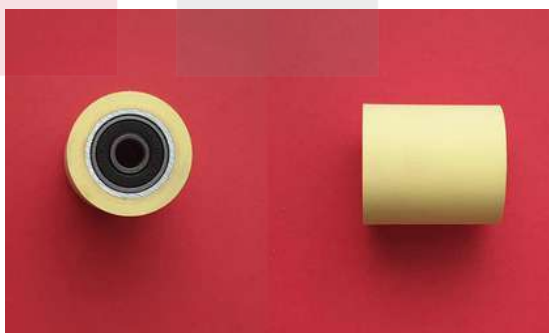



Ref	Medidas (mm)
R094-8	Ø30xØ18x60



Ref	Medidas (mm)
R094-9	Ø36xØ8x55

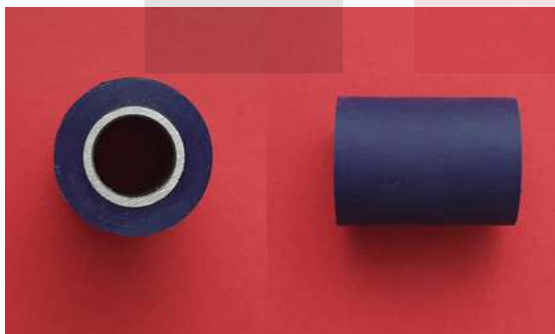

Ref	Medidas (mm)
R094-10	Ø40xØ20x55

RUEDAS CON COJINETE





Ref	Medidas (mm)
R090-8	Ø31xØ8x8



Ref	Medidas (mm)
R090-27	Ø30xØ8x10

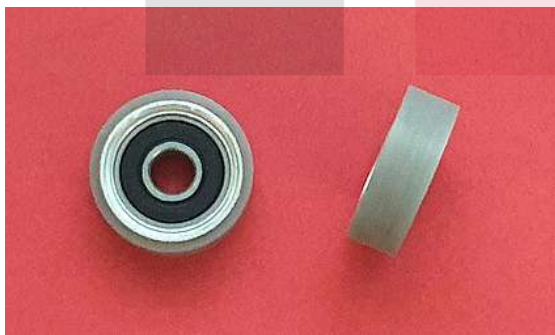

Ref	Medidas (mm)
R090-27PUR	Ø30xØ8x10

Ref	Medidas (mm)
R090-7	Ø31xØ8x10



Ref	Medidas (mm)
R090-9G	Ø36xØ8x10



Ref	Medidas (mm)
R090-9R	Ø37xØ8x10





Ref	Medidas (mm)
R090-35	Ø38xØ8x10



Ref	Medidas (mm)
R090-15	Ø40xØ8x10

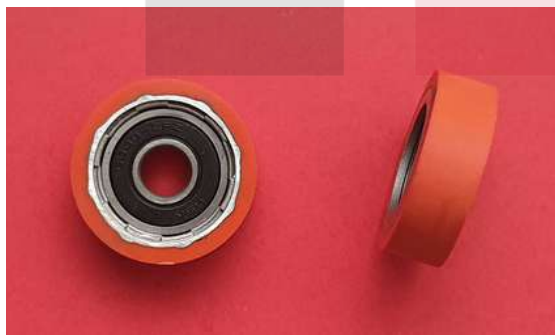

Ref	Medidas (mm)
R090-10	Ø37xØ10x12

**Otras medidas consultar*

Ref	Medidas (mm)
R090-4	Ø40xØ15x14

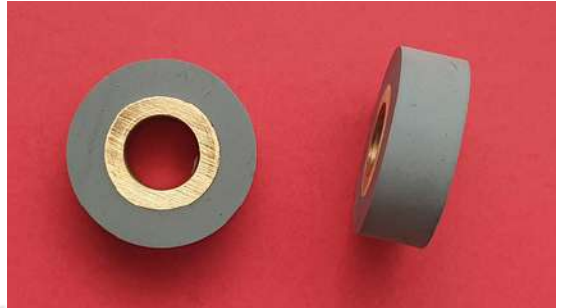

Ref	Medidas (mm)
R090-48	Ø48xØ8x18

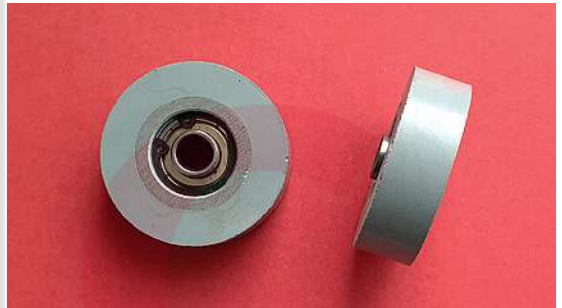

Ref	Medidas (mm)
R090-58	Ø38xØ8x15



Ref	Medidas (mm)
R090-72	Ø50xØ12x17



RESISTENCIAS CALDERÍN DE COLA





Ref	Medidas (mm)
RESPC	Ø6,35X136 200W 240V
RESHR-1	Ø8X67 140W 230V
RESHR	Ø8X80 400W 240V
RESLC-3	Ø8X100 400W 220V
RESBE	Ø8X120 350W 260V
RESHG-D	Ø8X130 220W 400V
RESHG-E	Ø8X130 100W 400V
RESCA-A	Ø10X50 160W 230V
RESM-G	Ø10X95 200W 240V
RESLC-5	Ø10X100 500W 240V



Ref	Medidas (mm)
RESBC	Ø10X100 600W 240V
RESGK	Ø10X130 800W 220V
RESM-L	Ø10X135 350W 240V
RESM-J	Ø10X200 350W 240V
RESLC-2	Ø12X100 400W 220V
RESLC-1	Ø12X128 600W 230V
RESLC-4	Ø12X132 600W 220V
RESM-K	Ø12,2X100 600W 240V
RESSC	Ø12,5X80 500W 230V
RESHG-B	Ø12,5X100 400W 400V
RESHG-C	Ø12,5X100 500W 400V
RESHG-A	Ø12,5X138 150W 400V
RESHG-F	Ø12,5X160 200W 220V



Ref	Medidas (mm)
RESBE-1	Ø12,5X200 1300W 260V
RESM-D	Ø13X80 270W 240V
RESM-H	Ø13X90 300W 240V
RESM-F	Ø13X110 350W 240V
RESM-E	Ø13X145 300W 240V
RESCA	Ø16X100 630W 240V
RESM-C	Ø16X128 600W 240V
RESM-B	Ø16X160 800W 240V
RESM-A	Ø16X165 1000W 240V
RESM-I	Ø16X250 1350W 240V

CARRIL DE ROLDANAS



Ref	Medidas (mm)
RLB107	1 metro



Ref	Medidas (mm)
RLB97-1	Ø28xØ3x26

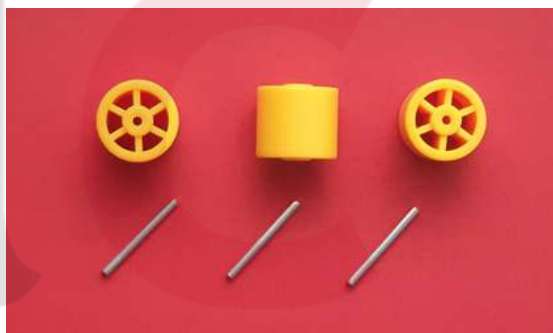

Ref	Medidas (mm)
RLB97-2	Ø28xØ3x26

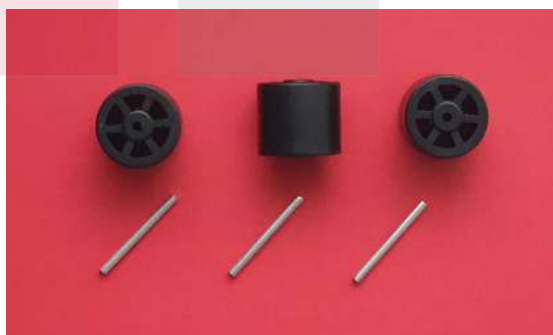

RUEDAS PARA CARRO ESCUADRADORAS Y LENTES

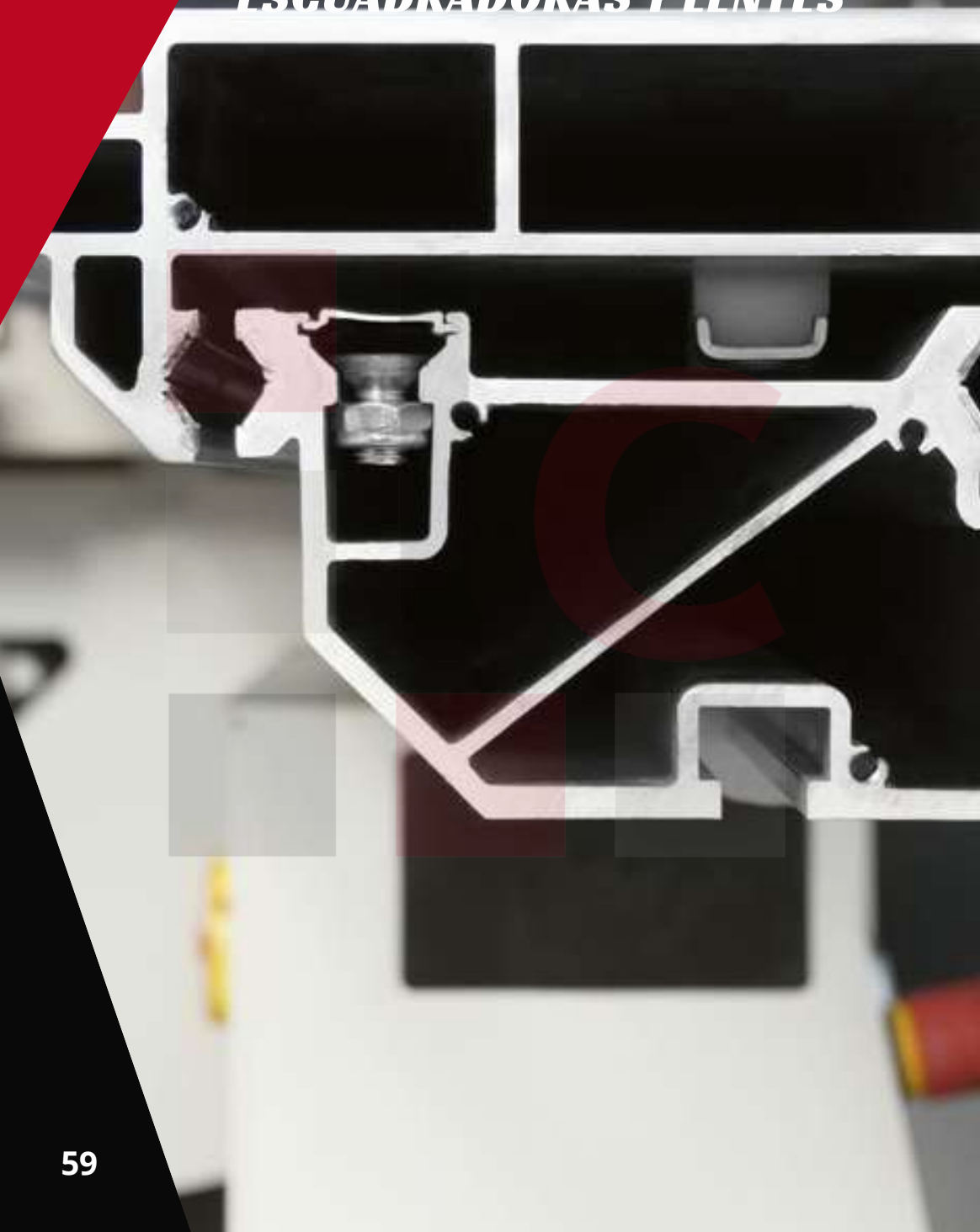

Ref	Medidas (mm)
RCE01	Ø38xØ12x13



Ref	Medidas (mm)
RCE02	Ø38xØ12x11



Ref	Medidas (mm)
RCE03	Ø42xØ15x16





Ref	Medidas (mm)
RCE04	Ø43xØ15x16



Ref	Medidas (mm)
RCE05	Ø48xØ12x16

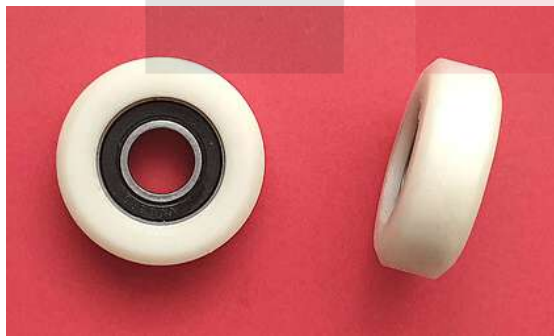

Ref	Medidas (mm)
RCE06	Ø48xØ15x16

Ref	Medidas (mm)
RCE01+EJE	Ø38xØ12x13

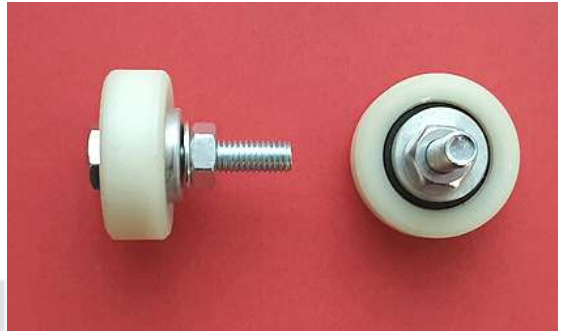

Ref	Medidas (mm)
RCE02+EJE	Ø38xØ12x11



Ref	Medidas (mm)
RCE03+EJE	Ø42xØ15x16





Ref	Medidas (mm)
RCE04+EJE	Ø43xØ15x16

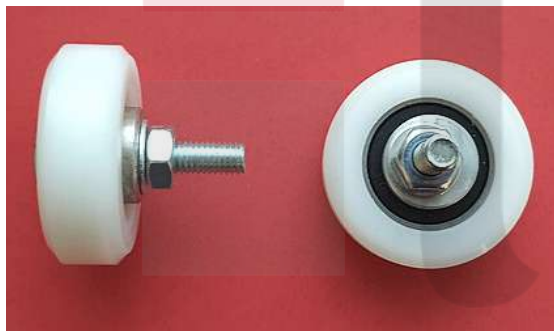

Ref	Medidas (mm)
RCE05+EJE	Ø48xØ12x16

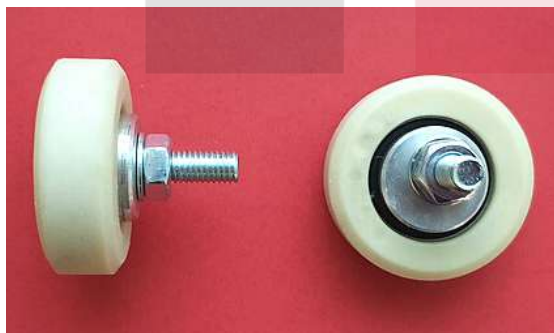

Ref	Medidas (mm)
RCE06+EJE	Ø48xØ15x16

Ref	Medidas (mm)
LME92-1	Ø45xØ31x18

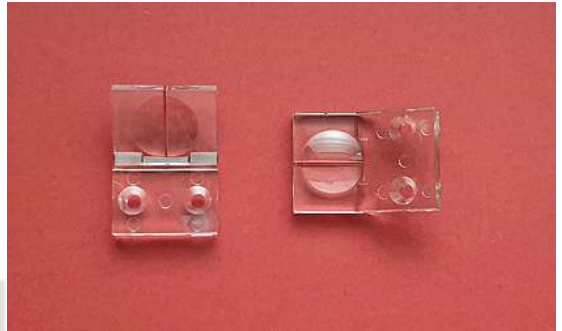

Ref	Medidas (mm)
LME92-2	Ø38xØ25x8



Ref	Medidas (mm)
PDE91-A	400 x 200 mm

Ref	Medidas (mm)
PDE91-B	300 x 200 mm

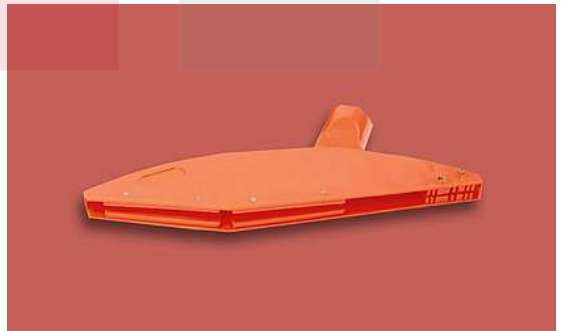

CNC: JUNTAS PARA VENTOSAS, VÁLVULAS Y FILTROS SECCIONADORAS: GOMA PRENSOR



Ref	Medidas (mm)
VSM50	Ø112xØ54x16,5

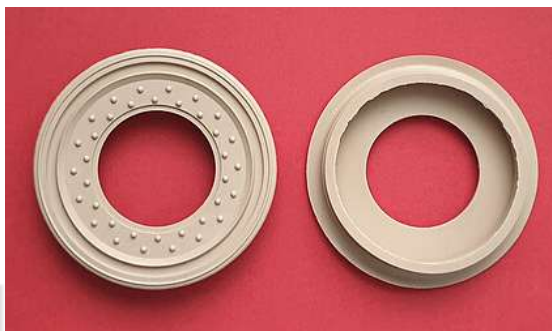

Ref	Medidas (mm)
VSM43	180x60x7

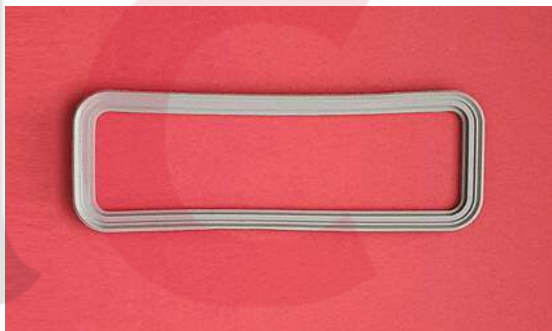

Ref	Medidas (mm)
VSM44	143x143x11





Ref	Medidas (mm)
VSM45	143x52x7



Ref	Medidas (mm)
VSM48	118x84x12

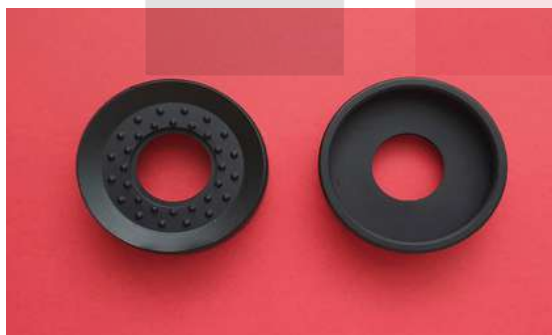

Ref	Medidas (mm)
VR65	Ø65xØ27x17

Ref	Medidas (mm)
VR85	Ø85xØ27x17



Ref	Medidas (mm)
VR114	Ø114xØ54x17



Ref	Medidas (mm)
GVE6	Ø 6 mm
GVE7	Ø 7 mm
GVE8	Ø 8 mm





Ref	Medidas (mm)
CNC22	Ø22xØ18,5x25,4



Ref	Medidas (mm)
CNC23	Ø15x0,9

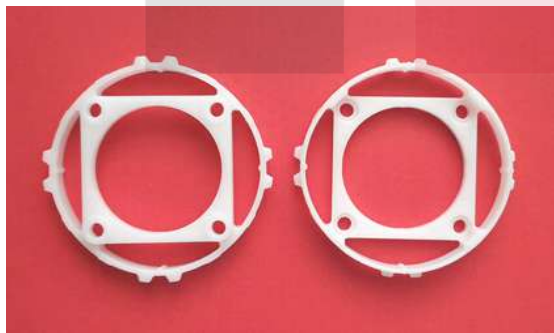

Ref	Medidas (mm)
CNC24	98x60x15

Goma autoadhesiva prensor de seccionadoras

Ref	Medidas (mm)
GPS1010	10X10 mm
GPS2010	20X10 mm
GPS2510	25X10 mm

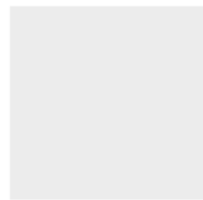
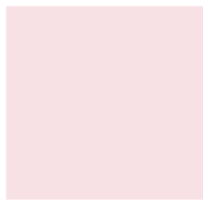
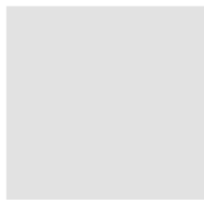
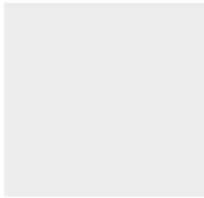
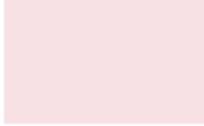

CONOS PORTAHERRAMIENTAS Y PINZAS



Ref **ISO30/ER32**

CPH80-R A=50;D=50;D1=50

CPH80-L A=50;D=50;D1=50

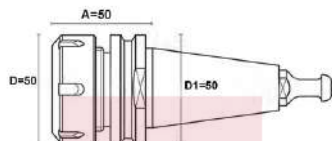

Ref **ISO30/ER32**

CPH70-R A=55;D=50;D1=49

CPH70-L A=55;D=50;D1=49

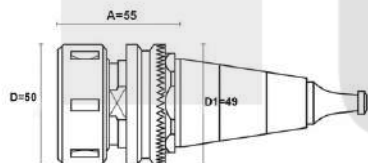

Ref **ISO30/ER32**

CPH81-R A=68;D=50;D1=50

CPH81-L A=68;D=50;D1=50

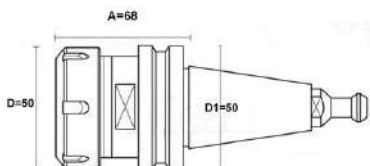



Ref **ISO30/ER40**

CPH83-R A=60;D=63;D1=50

CPH83-L A=60;D=63;D1=50

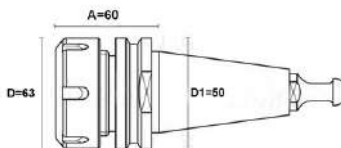

Ref **ISO30/ER40**

CPH814-R A=68;D=63;D1=50

CPH814-L A=68;D=63;D1=50

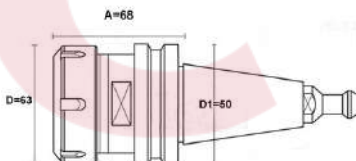

Ref **HSK63F/ER32**

CPH97-R A=75;D=50;D1=63

CPH97-L A=75;D=50;D1=63

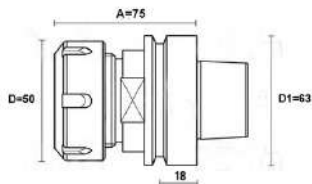

Ref **HSK63F/ER40**

CPH98-R A=75;D=63;D1=63

CPH98-L A=75;D=63;D1=63

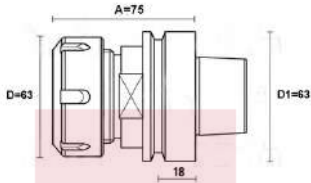

Ref **ER32**

PPH119 d= Ø 2-1 a Ø 20-19

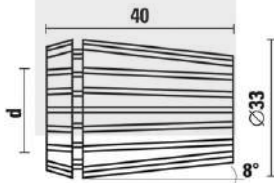

Ref **ER40**

PPH123 d= Ø 3-2 a Ø 30-29

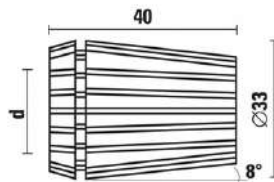



Ref	ISO30
PIN30	Pinzas ISO30



Ref	HSK63F
PIN63	Pinzas HSK63

RODILLOS DE ARRASTRE MOLDURERA - 4 CARAS

lenticant
WOODWORKING MACHINERY





Ref	Medidas (mm)
RGW117/50	Ø140xØ35x50



Ref	Medidas (mm)
RGW117B/50	Ø140xØ30x50

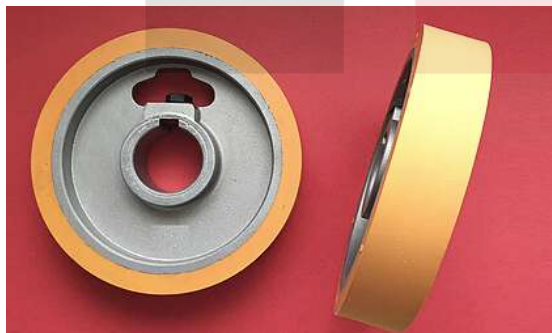

Ref	Medidas (mm)
RGW117/30	Ø140xØ35x30

Ref	Medidas (mm)
RGW117/15	Ø140xØ35x15



Ref	Medidas (mm)
RGM114	Ø120xØ30x50



Ref	Medidas (mm)
RGM114/20	Ø120xØ30x20





Ref	Medidas (mm)
RGG118	Ø120xØ25x20

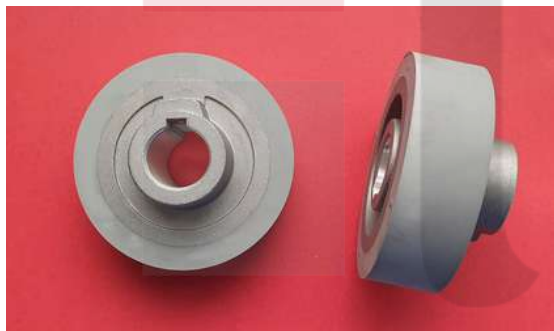

Ref	Medidas (mm)
RGW119	Ø95xØ25x50



Ref	Medidas (mm)
RGW111A-1	Ø140xØ35x25

Ref	Medidas (mm)
RGW111B-1	Ø140xØ35x15



Ref	Medidas (mm)
RGW112B-1	Ø120xØ30x25

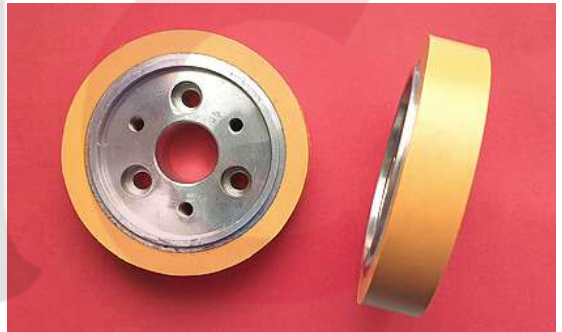

Ref	Medidas (mm)
RGW112C-1	Ø120xØ30x15





Ref	Medidas (mm)
RMW109-A	Ø140xØ35x50



Ref	Medidas (mm)
RMW109-B	Ø140xØ30x50

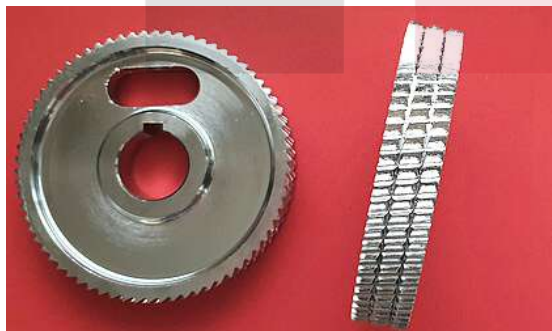

Ref	Medidas (mm)
RMW112	Ø140xØ35x25

Ref	Medidas (mm)
RMW111-A	Ø140xØ35x25



Ref	Medidas (mm)
RMW111-B	Ø140xØ35x15



Ref	Medidas (mm)
RMW112C	Ø120xØ30x15



RODILLOS ALIMENTADOR TUPÍ



**Otras medidas consultar*

Ref	Medidas (mm)
RGT113/60	Ø120xØ35x60



Ref	Medidas (mm)
RGT113/60B	Ø120xØ35x60



Ref	Medidas (mm)
RGT113/50	Ø120xØ35x50



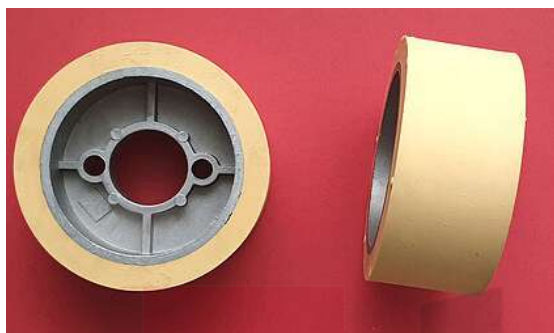

Ref	Medidas (mm)
RGT113-S	Ø110xØ35x50

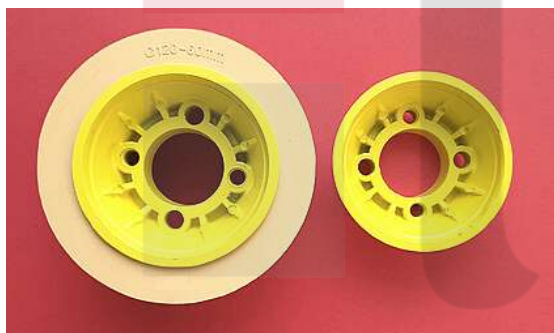

Ref	Medidas (mm)
RGT115+SET	Ø120xØ50x60



Ref	Medidas (mm)
RGT116	Ø100xØ20x60

**Otras medidas consultar*

Ref	Medidas (mm)
RGT104	Ø80xØ22x28

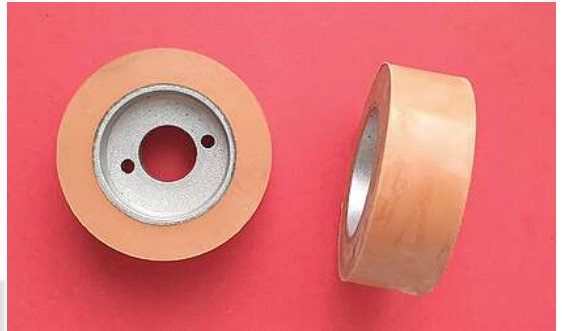

Ref	Medidas (mm)
RMT120/60	Ø120xØ35x60

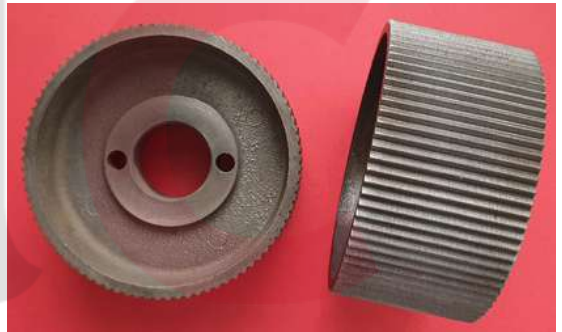



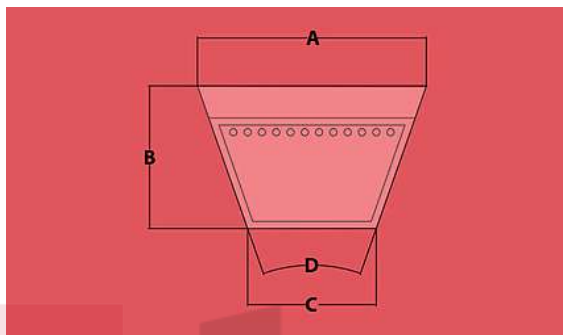

C1*

REF	MEDIDAS				PERFILES						
	A	B	C	D	RbG	RbP	GrA	Ls	LsR	2HL	3HL
C1-1	32	20	18	38	X	X	X	X	X	X	
C1-2	32	22	20	40			X				X
C1-3	25	16	14	38		X	X	X	X	X	
C1-4	22	14		38		X	X	X	X	X	
C1-5	17	11		38		X	X	X	X	X	
C1-6	13	8		38		X	X	X	X	X	

*Compatibles con

*C1-1: HOMAG-STEFANI-BIESSE-GABBIANI-CELASCHI

*C1-2: FRIULMAC

*C1-3: HOMAG

*C1-4; *C1-5; *C1-6: Varios

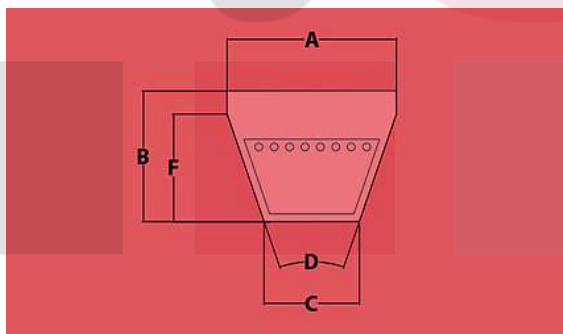

C2*

REF	MEDIDAS				PERFILES						
	A	B	C	D	RbG	RbP	GrA	Ls	LsR	2HL	3HL
C2-1	10	6		38			X	X	X	X	
C2-2	13	8		38		X	X	X	X	X	
C2-3	17	11		38		X	X	X	X	X	
C2-4	22	14		38		X	X	X	X	X	

*Compatibles con

*C2: Varios

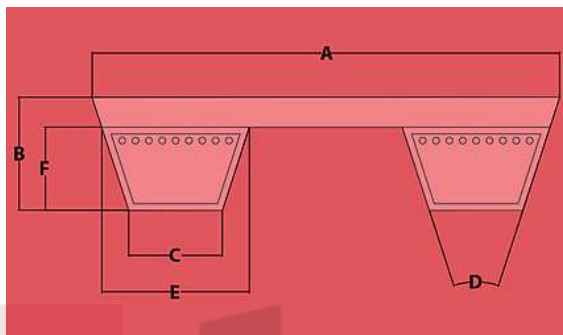

C3*

REF	MEDIDAS						PERFILES	
	A	B	C	D	E	F	LsR	5HL
C3-1	58	20	9	40	17	15	X	
C3-2	64	20	9	40	17	11		X

**Compatibles con*

**C3-1: Varios*

**C3-2: EGURKO-ELWOOD*

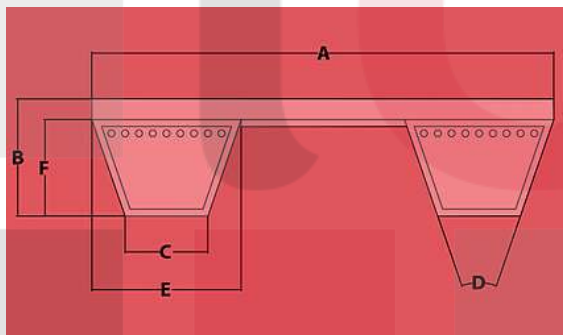

C4*

REF	MEDIDAS						PERFILES							
	A	B	C	D	E	F	RbG	RbP	GrA	Ls	LsR	3HL	4HL	6HL
C4-1	70	19	14	38	22	14	X	X						
C4-2	70	17	14	38	22	14					X			
C4-3	67	17	12	38	22	14			X		X			
C4-4	60	17	12	40	22	14							X	
C4-5	65	23	12	40	22	14					X		X	
C4-6	65	18	12	40	22	14								X

**C4-1: IMA*

**C4-2: HOMAG*

**C4-3: BIESSE-HOLZGER-STEFANI-FRIULMAC*

**C4-4: GABBIANI*

**C4-5: STEFANI*

**C4-6: STEFANI-NARDELLO*

**Compatibles con*

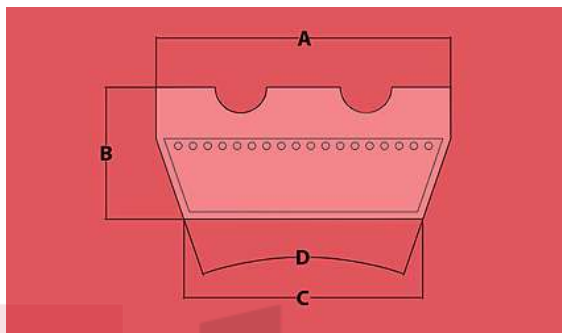

C5*

REF	MEDIDAS				PERFILES		
	A	B	C	D	2HL	3HL	4HL
C5-1	45	15	40	30		X	
C5-2	40	20	33	30	X		
C5-3	49	20	41	30			X
C5-4	50	15		34		X	

*Compatibles con

- *C5-1: A.COSTA
- *C5-2: TAGLIABUE
- *C5-3: EGURKO
- *C5-4: OLIMPIC

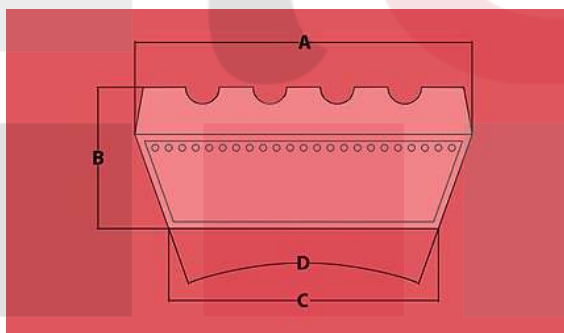

C6*

REF	MEDIDAS				PERFILES
	A	B	C	D	4HL
C6-1	50	19	42	40	X
C6-2	50	21	40	40	X

*Compatibles con

- *C6-1: GABBIANI
- *C6-2: GABBIANI

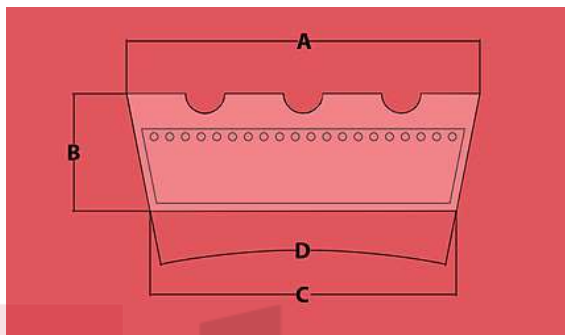

C7*

REF	MEDIDAS				PERFILES	
	A	B	C	D	3HL	4HL
C7-1	45	15	39	25	X	
C7-2	40	12	33	30	X	
C7-3	60	16	52	25		X

*Compatibles con

*C7-1: MANEA

*C7-2: SPANEVELLO-A.COSTA

*C7-3: SPANEVELLO-SICAR

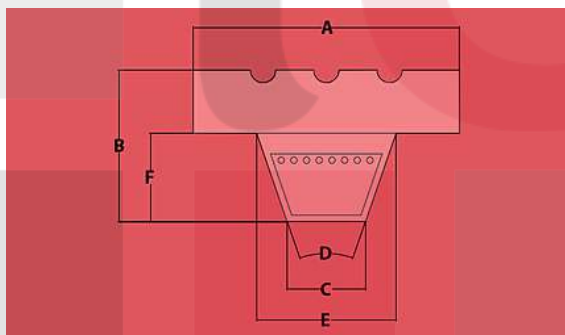

C8*

REF	MEDIDAS						PERFILES		
	A	B	C	D	E	F	LsR	2HL	3HL
C8-1	42	24	12	38	22	14	X		X
C8-2	30	25	9	38	17	11		X	
C8-3	28	25	12	38	22	14	X		

*Compatibles con

*C8-1: A.COSTA

*C8-2: TAGLIABUE

*C8-3: FRIULMAC

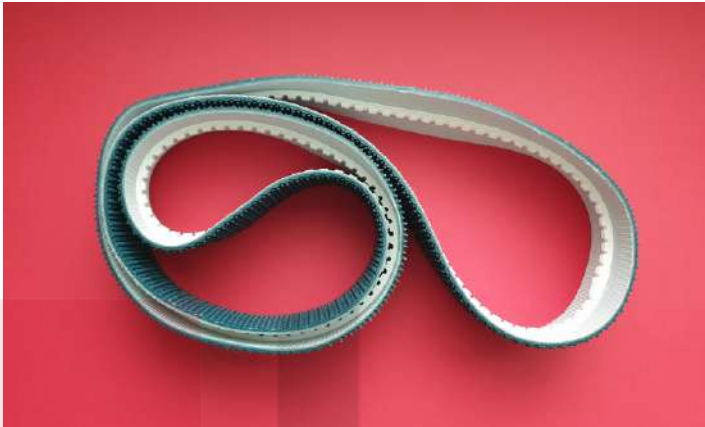

Ref	Medidas (mm)
C2272	2200x72 mm

**Con perfil 6x10 mm al centro
cara inferior, cerrada sin fin**

*Compatibles con: SCM - Minimax, Tecnomax
FELDER - CASADEI INDUSTRIA

POLEAS, RUEDAS y MULTIDIRECCIONALES

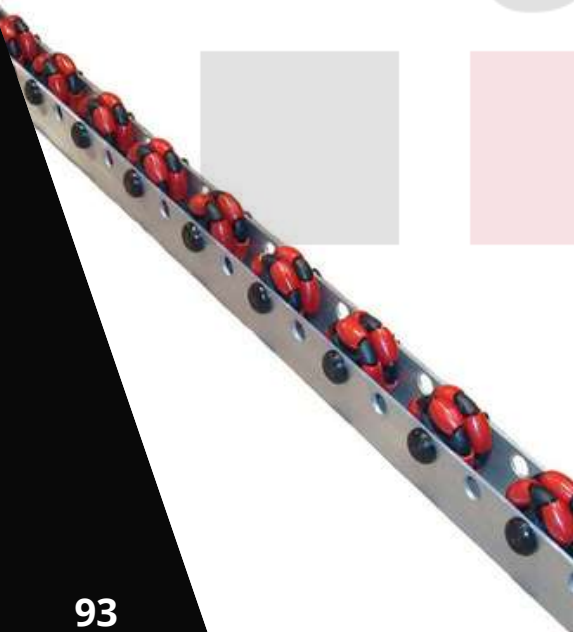

Ref	Medidas (mm)
R075-1	Ø47xØ12x16



Ref	Medidas (mm)
R075-2	Ø48xØ8x16

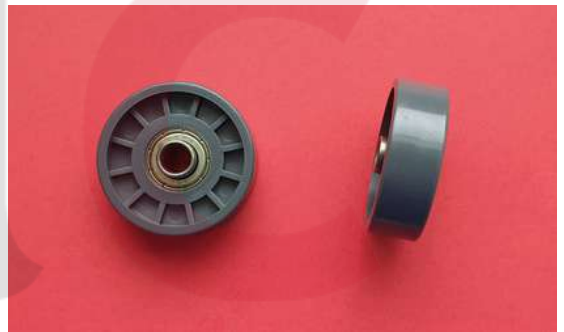

Ref	Medidas (mm)
R076-1	Ø60xØ6x42





Ref	Medidas (mm)
R076-2	Ø60xØ6x42



Ref	Medidas (mm)
R076-3	Ø50xØ8x15



Ref	Medidas (mm)
R079-3	Ø45xØ15x32

Ref	Medidas (mm)
R079-6	Ø55xØ15x23



Ref	Medidas (mm)
R079-9	Ø52xØ10x32
	3 cojinetes



Ref	Medidas (mm)
R079-10	Ø60xØ30x66





Ref	Medidas (mm)
R079-16	Ø50xØ10x23



Ref	Medidas (mm)
R093	Ø59xØ15xL46xH53



Ref	Medidas (mm)
R093A	Ø65xØ17xL41xH52

Ref	Medidas (mm)
R093B	Ø65xØ15xL15xH18



Ref	Medidas (mm)
R093C	Ø51xØ12xL40xH53



Ref	Medidas (mm)
R093F	Ø60xØ17xL46xH53





Ref	Medidas (mm)
R093F2	Ø60xØ15xL46xH53

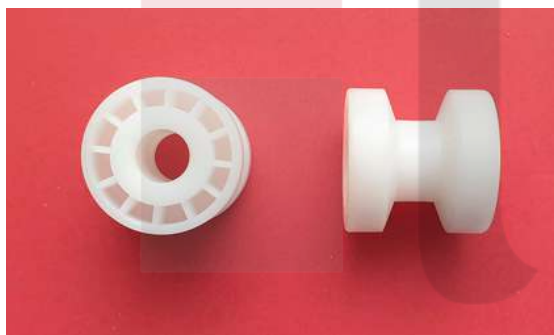

Ref	Medidas (mm)
R081-2	Ø44xØ15x43

LÍQUIDOS DE LIMPIEZA Y GRUPO DE PULVERIZACIÓN



OMNICLEAN

**Potente limpiador
BASE AGUA
de superficies delicadas**





Ref	Spray (ml)
LC5/100	500 ml

Spray antiadherente libre de siliconas ideal para pulverizar sobre los rodillos de presión del canto, herramientas y palpadores de los grupos de la chapadora/encoladora de cantos y evitar que los restos de colas se adhieran.



OMNICLEAN
 Potente limpiador
 BASE AGUA
 de superficies delicadas

Ref	Spray (ml)
OMNICLEAN	500 ml

OMNICLEAN es un potente limpiador manual BASE AGUA especialmente indicado para uso en superficies delicadas: melamina mate, alto brillo, laminados, lacados, pvc... Especialmente indicado para eliminar restos de cola, adhesivos, grasas, huellas, partículas de polvo...

Evapora rápidamente sin dejar residuos. Modo de empleo: pulverizar sobre la superficie, dejar actuar unos segundos y retirar con un paño seco.

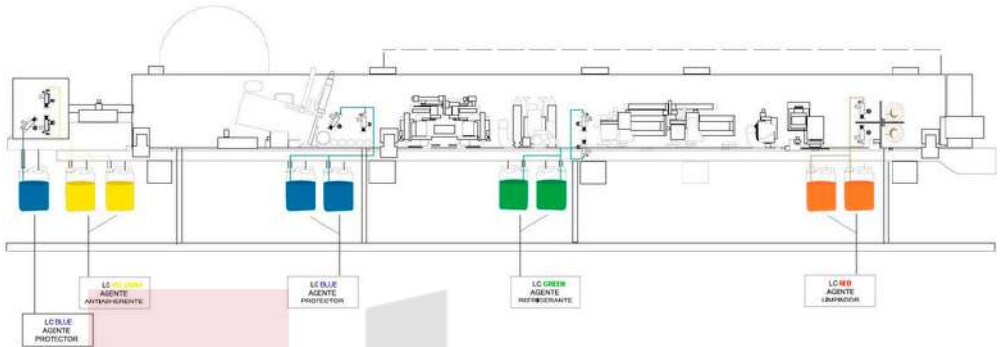

Ref	Garrafa (lt)
LC-BLUE	25 lt

El agente Protector se pulveriza automáticamente sobre los rodillos de presión, evitando que los restos de cola queden adheridos sobre ellos y que los cantos se manchen.

Algunos cantos incorporan un film protector para protegerlos en el proceso de canteado, el problema es que las cuchillas de las máquinas normalmente dañan el film protector y lo despegan. Para evitar esto, el Agente Protector consigue dotar al canto de una película que ayuda a que el film deslice en las cuchillas y no llegue a levantarse.



Ref	Garrafa (lt)
LC-YELLOW	25 lt

El agente antiadherente se debe pulverizar automáticamente antes de la tupí de entrada, arriba y abajo del tablero junto a la zona del canto, en las partes visibles de la pieza dejando una película de protección que posteriormente se evapora obteniendo como resultado una ausencia total de restos de cola sobre el tablero.





Ref	Garrafa (lt)
LC-GREEN	25 lt

El Agente Refrigerante/Antiestático se utiliza delante del grupo de refilado, pulverizado automáticamente en la parte superior e inferior del tablero, junto al canto proporcionando un enfriamiento inmediato de la cola y limpiando al mismo tiempo el lado superior e inferior de los cantos. Además, reduce la electricidad estática ocasionada por el perfilado de los cantos, con el fin de que los restos de PVC o ABS no se queden adheridos en la máquina o en las piezas a cantear.



Ref	Garrafa (lt)
LC-RED	25 lt

El Agente Limpiador se pulveriza automáticamente en la parte superior e inferior del tablero junto al canto, inmediatamente antes de los cepillos de limpieza/discos de pulir. Su función es eliminar los restos de adhesivo para que el tablero salga de la máquina completamente limpio.



Ref	Garrafa (lt)
LCC/5	5 lt

Líquido para limpieza de calderines de cola de chapadoras/encoladoras de cantos



Ref
LC8/50

El sistema de pulverización está dotado de un sensor láser que detecta cuando la pieza a cantear pasa por delante e inmediatamente manda la orden a la parte electrónica para que se pulverice a través de las boquillas de pulverización, los distintos agentes antiadherentes y limpiadores. Las boquillas que lo componen no son sensibles al polvo y poseen la posibilidad de ajustar con gran sensibilidad la cantidad de producto pulverizado.

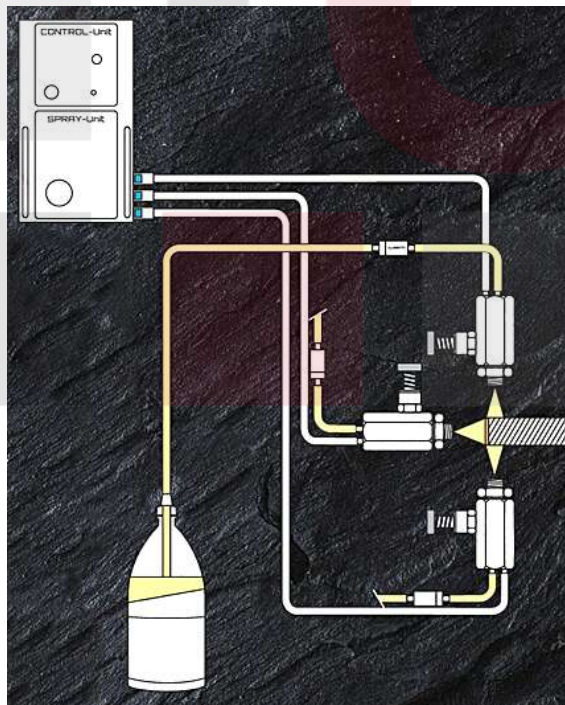

SOLUTIONS

EL MEJOR OPTIMIZADOR PARA PLANOS DE CORTE DEL MERCADO

- Mayor ahorro de tiempo y material
- Programa fácil de aprender
- Control preciso de la producción
- Excelente gestión del almacén de tableros y restos
- Impresión de etiquetas con códigos de barras
- Importa/exporta archivos en cualquier formato
- Post procesador para conexión con todas las seccionadoras del mercado

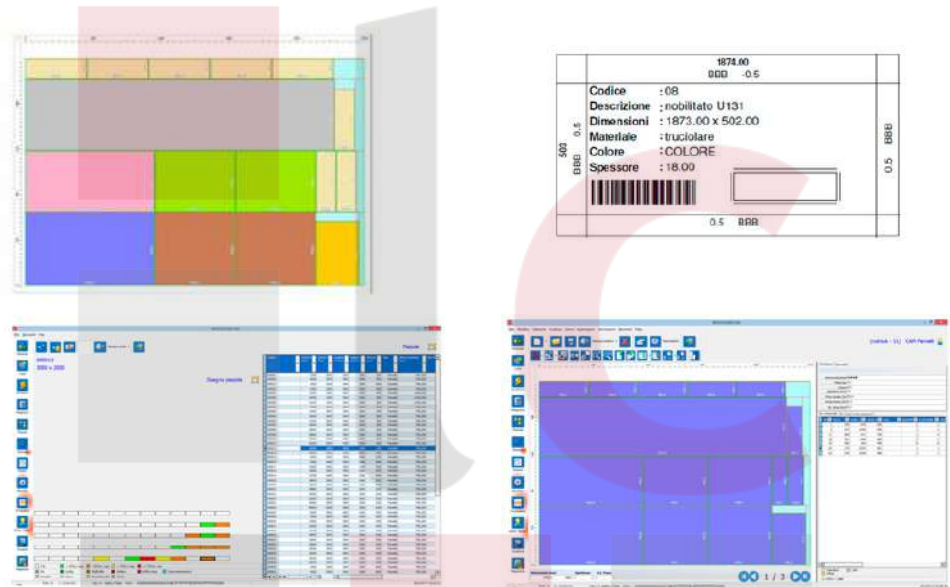

DISPONIBLE EN LAS SIGUIENTES VERSIONES (*consúltenos y le asesoraremos)

SILVER



GOLD



PLATINUM



DIAMOND





**ATENDEMOS SUS
SOLICITUDES**

24 horas / 7 días



ENVÍOS 24 horas

lenticant[®]

WOODWORKING MACHINERY

www.lenticant.com



lenticant@lenticant.com



+34 655 910 893



+34 671 637 565



www.lenticant.com